



CATÁLOGO
 **RAESA**®
DIVISIÓN PERFILES DE ALUMINIO

CATÁLOGO
MANUAL B - Línea 3005

INDICE

3005 / 01 - pág 1

Marco ventana corrediza

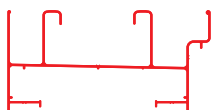

3005 / 20 - pág 5

Guía p/ cortina



3005 / 69 - pág 8

Perfil unión 75 mm



3005 / 01R - pág 2

Marco ventana corrediza

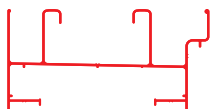

3005 / 21 - pág 5

Tapa cinta



3005 / 75 - pág 9

Marco unific. con Postigón rebatir



3005 / 02 - pág 1

Zócalo y cabezal ventana corrediza



3005 / 24 - pág 9

Marco p/ hoja corrediza



3005 / 76 - pág 3

Parante hoja postigo



3005 / 02R - pág 2

Zócalo y cabezal ventana corrediza



3005 / 25 - pág 1

Travesaño vidrio repartido



3005 / 77 - pág 3

Marco 31 mm.



3005 / 03 - pág 1

Pañante lateral ventana corrediza



3005 / 26 - pág 1

Bastidor vidrio repartido



3005 / 79 - pág 3

Marco puerta 25



3005 / 03R - pág 2

Parante lateral ventana corrediza



3005 / 27 - pág 7

Hoja inferior proyectante



3005 / 80 - pág 5

Tablilla postigón



3005 / 04 - pág 1

Parante central ventana corrediza



3005 / 31 - pág 5

Contramarco



3005 / 81 - pág 5

Revestimiento doble faz



3005 / 04R - pág 2

Parante central ventana corrediza



3005 / 33 - pág 4

Revestimiento tubular



3005 / 85 - pág 8

Columna de acople



3005 / 05 - pág 1

Mosquitero



3005 / 36 - pág 4

Marco puerta 36



3005 / 86 - pág 8

Acople en esquina

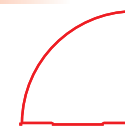

3005 / 06 - pág 7

Paño fijo



3005 / 37 - pág 4

Zócalo y travesaño inferior puerta 36

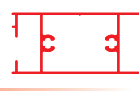

3005 / 88 - pág 6

Contravidrio



3005 / 07 - pág 7

Contravidrio



3005 / 38 - pág 4

Batiente puerta 36

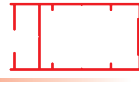

3005 / 90 - pág 1

Travesaño de mosquitero



3005 / 09 - pág 4

Parante puerta



3005 / 39 - pág 6

Marco puerta

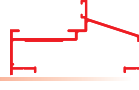

3005 / 91 - pág 9

Marco corredizo con 3 guías



3005 / 10 - pág 5

Marco aireador



3005 / 40 - pág 4

Doble contacto

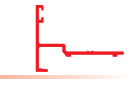

3005 / 92 - pág 6

Parante



3005 / 13 - pág 3

Batiente puerta 25



3005 / 41 - pág 6

Travesaño



3005 / 94 - pág 7

Travesaño paño fijo

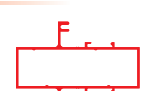

3005 / 15 - pág 7

Bisagra



3005 / 42 - pág 6

Parante



3005 / 109 - pág 4

Parante puerta 36 mm. corte a 45



3005 / 16 - pág 7

Marco y banderola proyectante



3005 / 44 - pág 3

Travesaño inf. puerta 25 y hoja ventana corrediza

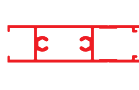

3005 / 113 - pág 3

Batiente puerta 25 corte a 45



3005 / 17 - pág 9

Umbral puerta corrediza



3005 / 53 - pág 2

Parante lateral reforzado

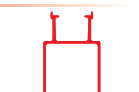

3005 / 168 - pág 9

Guía corrediza con mosquitero



3005 / 18 - pág 7

Hoja proyectante



3005 / 54 - pág 2

Parante central reforzado



3005 / 169 - pág 9

Marco unific. con Postigón corredizo



3005 / 19 - pág 3

Encuentro central



3005 / 68 - pág 3

Marco puerta recto 25



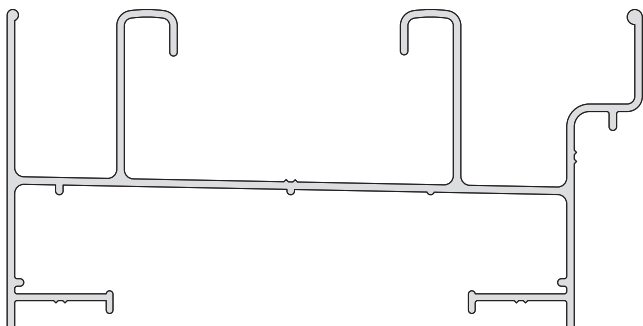

3005 / 01

Marco ventana corrediza
 726 grs / mt.
 8 barras de 6.150 mm.

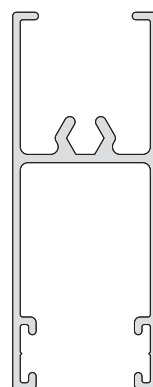

3005 / 02

Zócalo y cabezal ventana corrediza
 416 grs / mt.
 12 barras de 6.050 mm.

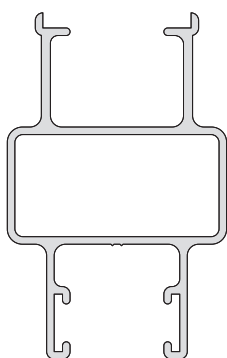

3005 / 03

Parante lateral ventana corrediza
 462 grs / mt.
 12 barras de 6.050 mm.

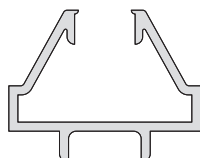

3005 / 26

Bastidor vidrio repartido
 243 grs / mt.
 18 barras de 6.050 mm.

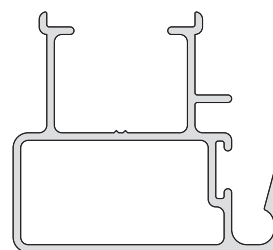

3005 / 04

Parante central ventana corrediza
 419 grs / mt.
 12 barras de 6.050 mm.

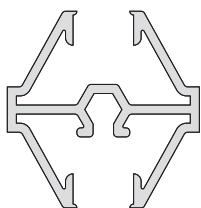

3005 / 25

Travesaño vidrio repartido
 359 grs / mt.
 18 barras de 6.050 mm.

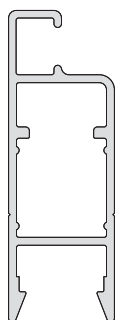

3005 / 05

Mosquitero
 328 grs / mt.
 18 barras de 6.050 mm.

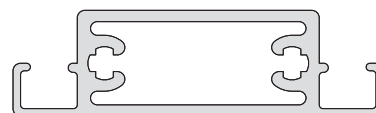

3005 / 90

Travesaño de mosquitero
 Peso 543 grs / mt.
 8 barras de 6.050 mm.

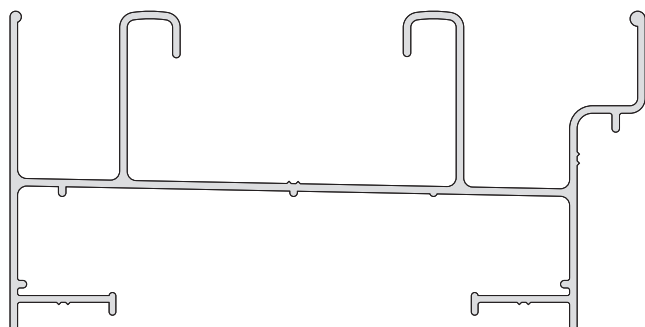

3005 / 01R

Marco ventana corrediza
 752 grs / mt.
 8 barras de 6.150 mm.

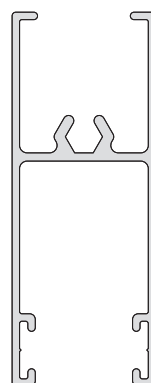

3005 / 02R

Zócalo y cabezal ventana corrediza
 456 grs / mt.
 12 barras de 6.050 mm.

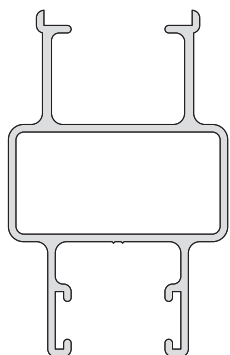

3005 / 03R

Parante lateral ventana corrediza
 474 grs / mt.
 12 barras de 6.050 mm.

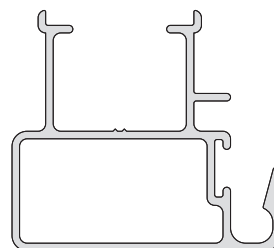

3005 / 04R

Parante central ventana corrediza
 457 grs / mt.
 12 barras de 6.050 mm.

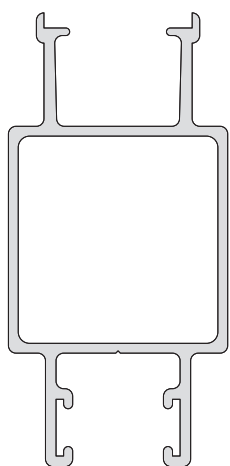

3005 / 53

Parante lateral reforzado
 700 grs / mt.
 9 barras de 6.200 mm.

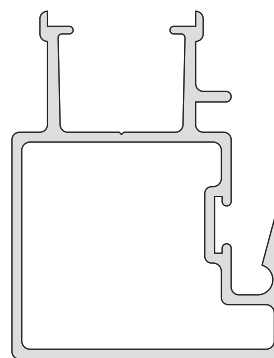

3005 / 54

Parante central reforzado
 694 grs / mt.
 9 barras de 6.200 mm.

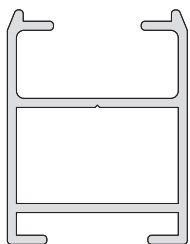

3005 / 76

Parante hoja postigo
 394 grs / mt.
 15 barras de 6.200 mm.

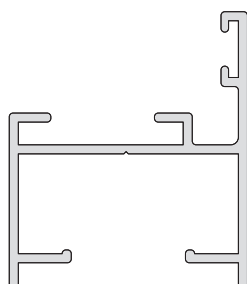

3005 / 77

Marco 31 mm.
 394 grs / mt.
 15 barras de 6.200 mm.

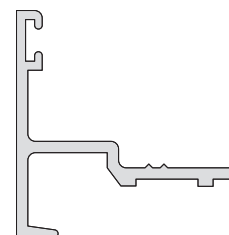

3005 / 19

Encuentro central
 284 grs / mt.
 15 barras de 6.200 mm.

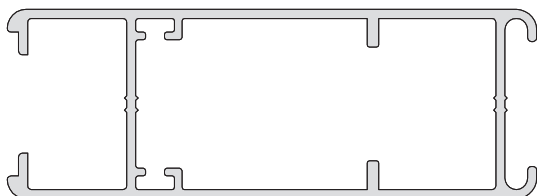

3005 / 113

Batiente puerta 25 corte a 45
 718 grs / mt.
 8 barras de 6.050 mm.

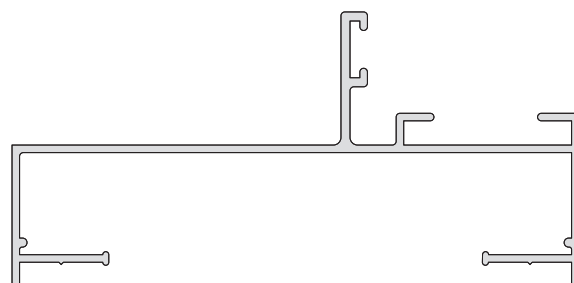

3005 / 68

Marco puerta recto 25
 495 grs / mt.
 12 barras de 6.200 mm.

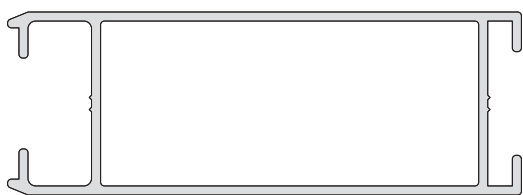

3005 / 13

Batiente puerta 25
 640 grs / mt.
 10 barras de 6.200 mm.

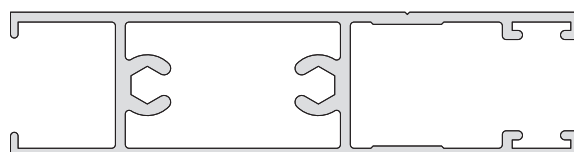

3005 / 44

Travesaño inf. puerta 25
 y hoja ventana corrediza
 854 grs / mt.
 6 barras de 6.050 mm.

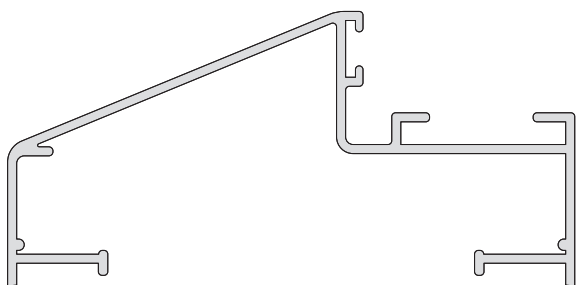

3005 / 79

Marco puerta 25
 608 grs / mt.
 8 barras de 6.200 mm.

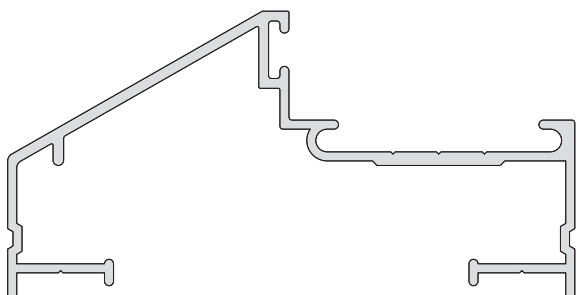

3005 / 36

Marco puerta 36
 655 grs / mt.
 8 barras de 6.200 mm.

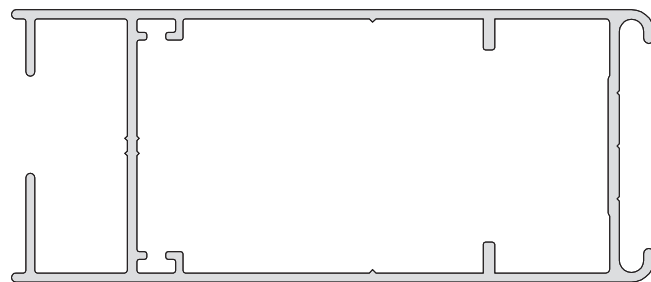

3005 / 109

Parante puerta 36 mm. corte a 45
 945 grs / mt.
 6 barras de 6.050 mm.

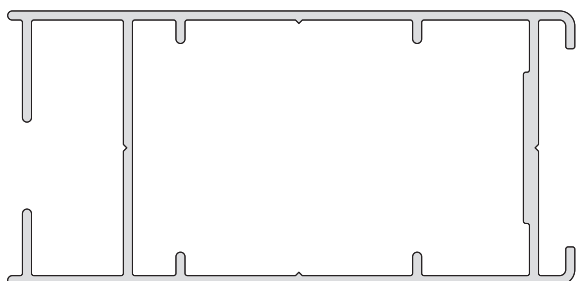

3005 / 38

Batiente puerta 36
 879 grs / mt.
 6 barras de 6.200 mm.

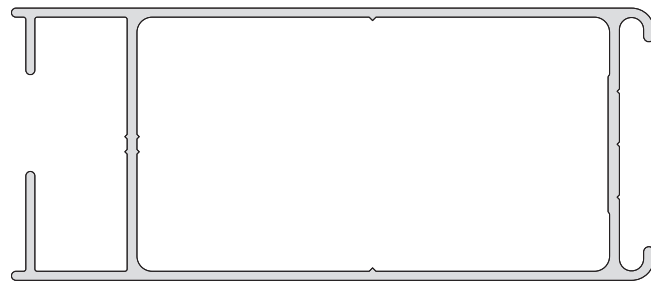

3005 / 09

Parante puerta
 891 grs / mt.
 6 barras de 6.150 mm.

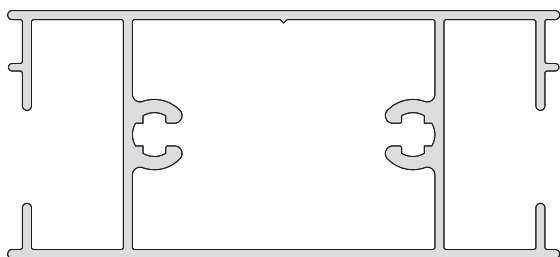

3005 / 37

Zócalo y travesaño
 inferior puerta 36
 952 grs / mt.
 6 barras de 6.200 mm.

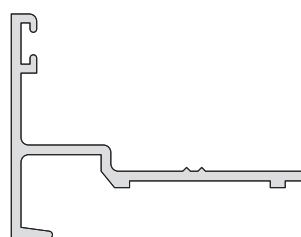

3005 / 40

Doble contacto
 Peso 289 grs / mt.
 15 barras de 6.050 mm.



3005 / 33

Revestimiento tubular
 997 grs / mt.
 6 barras de 6.050 mm.

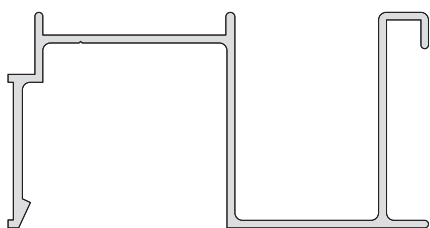

3005 / 20
 Guía p/ cortina
 428 grs / mt.
 14 barras de 6.050 mm.



3005 / 21
 Tapa cinta
 420 grs / mt.
 14 barras de 6.050 mm.

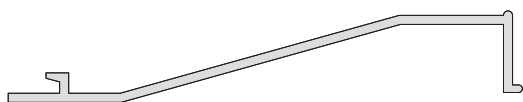

3005 / 80
 Tablilla postigón
 267 grs / mt.
 20 barras de 6.200 mm.

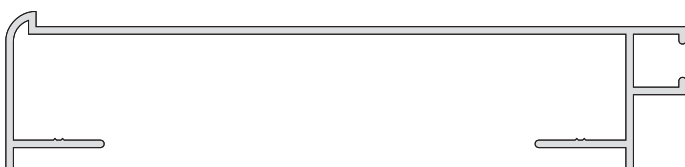

3005 / 10
 Marco aireador
 437 grs / mt.
 12 barras de 6.050 mm.

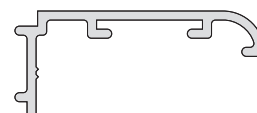

3005 / 31
 Contramarco
 194 grs / mt.
 20 barras de 6.050 mm.



3005 / 81
 Revestimiento doble faz
 595 grs / mt.
 7 barras de 6.050 mm.

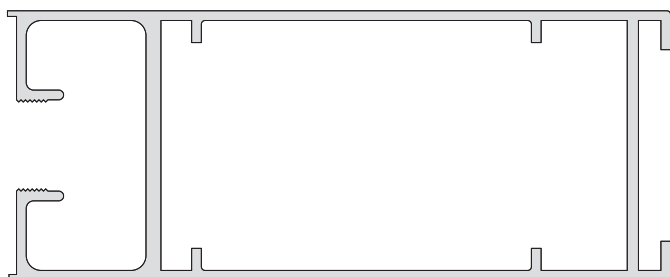

3005 / 42

Parante
 1102 grs / mt.
 6 barras de 6.150 mm.

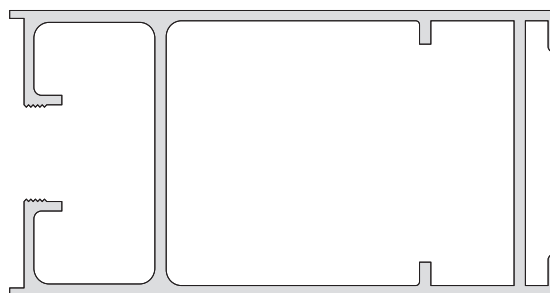

3005 / 92

Parante
 961 grs / mt.
 6 barras de 6.150 mm.

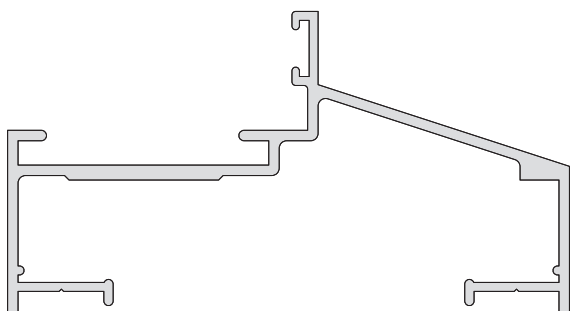

3005 / 39

Marco puerta
 713 grs / mt.
 8 barras de 6.150 mm.



3005 / 41

Travesaño
 1018 grs / mt.
 6 barras de 6.000 mm.

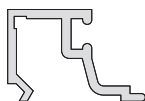

3005 / 88

Contra vidrio
 132 grs / mt.
 30 barras de 6.000 mm.

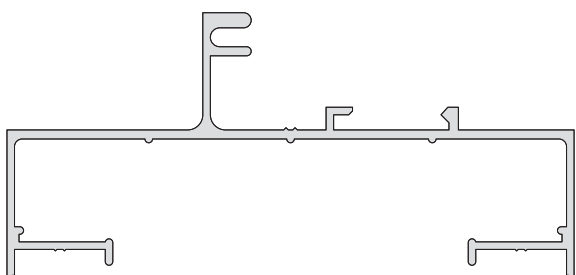

3005 / 06

Paño fijo
 559 grs / mt.
 10 barras de 6.050 mm.

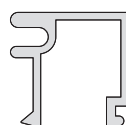

3005 / 07

Contravidrio
 161 grs / mt.
 25 barras de 6.050 mm.

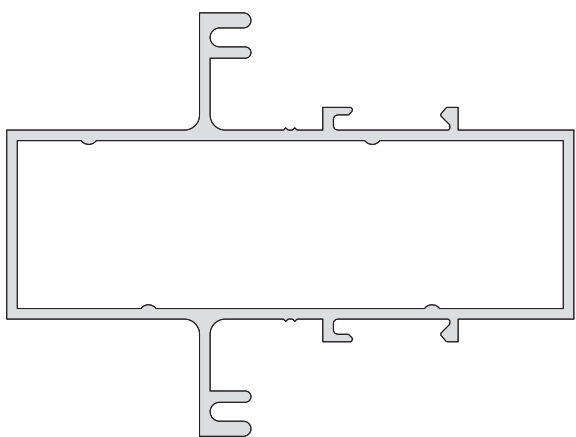

3005 / 94

Travesaño paño fijo
 1037 grs / mt.
 6 barras de 6.050 mm.

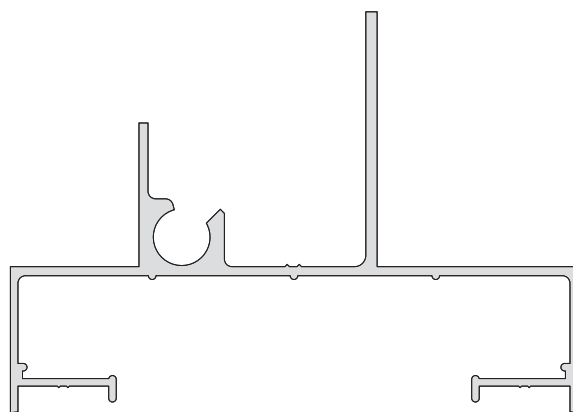

3005 / 16

Marco y banderola proyectante
 Peso 729 grs / mt.
 4 barras de 6.050 mm.

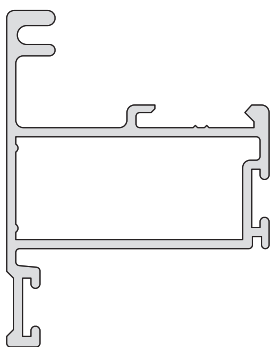

3005 / 18

Hoja proyectante
 Peso 547 grs / mt.
 10 barras de 6.050 mm.

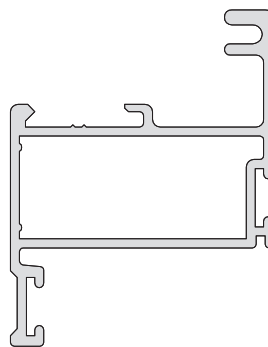

3005 / 27

Hoja inferior proyectante
 Peso 547 grs / mt.
 8 barras de 6.050 mm.

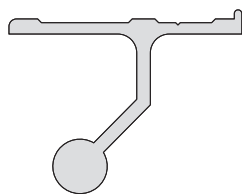

3005 / 15

Bisagra
 Peso 344 grs / mt.
 8 barras de 6.050 mm.

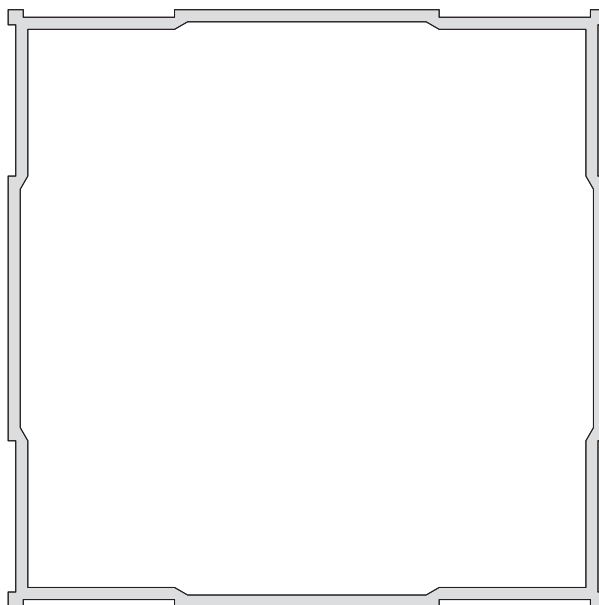

3005 / 85

Columna de acople
1.353 grs / mt.
4 barras de 6.050 mm.

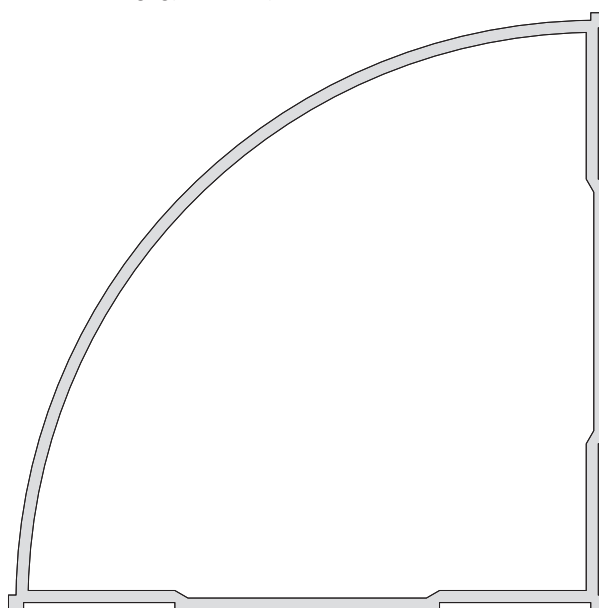

3005 / 86

Acople en esquina
Peso 1.196 grs / mt.
2 barras de 6.050 mm.



3005 / 69

Perfil unión 75 mm
419 grs / mt.
15 barras de 6.050 mm.

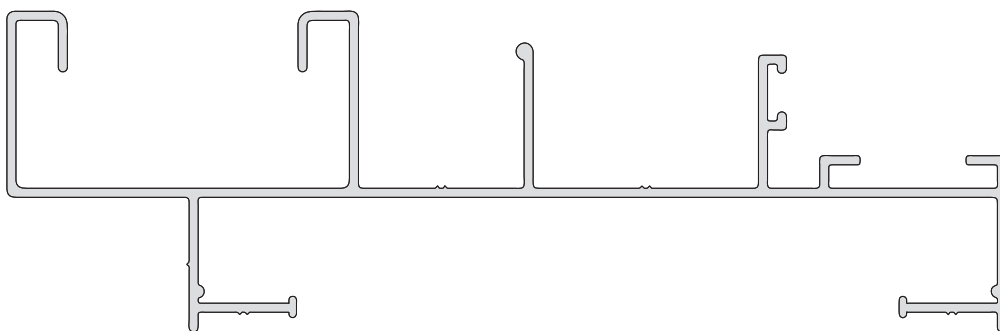

3005 / 75

Marco unific. con Postigón rebatir
 Peso 1.080 grs / mt.
 4 barras de 6.150 mm.

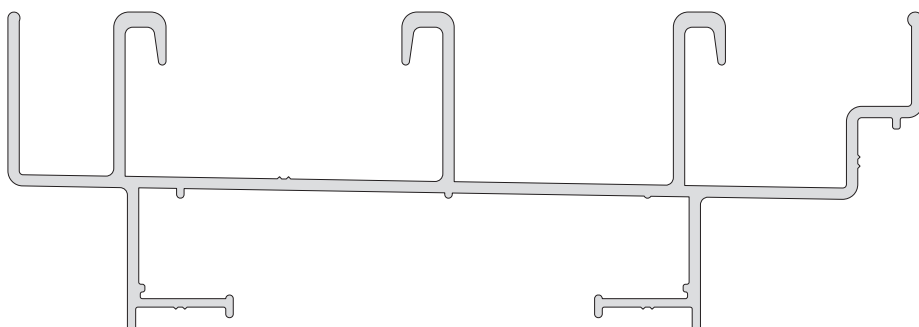

3005 / 91

Marco corredizo con 3 guías
 Peso 1.304 grs / mt.
 4 barras de 6.150 mm.

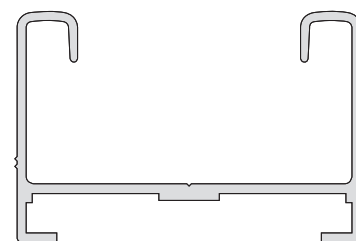

3005 / 24

Marco p/ hoja corrediza
 467 grs / mt.
 12 barras de 6.150 mm.

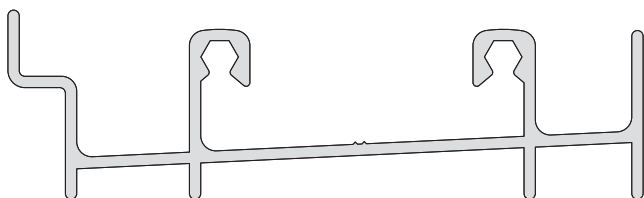

3005 / 17

Umbral puerta corrediza
 Peso 818 grs / mt.
 4 barras de 6.050 mm.

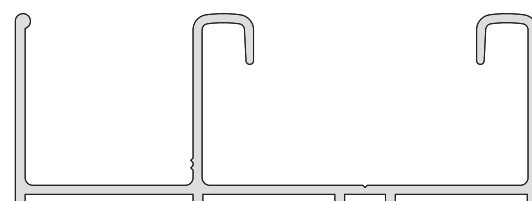

3005 / 168

Guía corrediza con mosquitero
 Peso 540 grs / mt.
 4 barras de 6.150 mm.

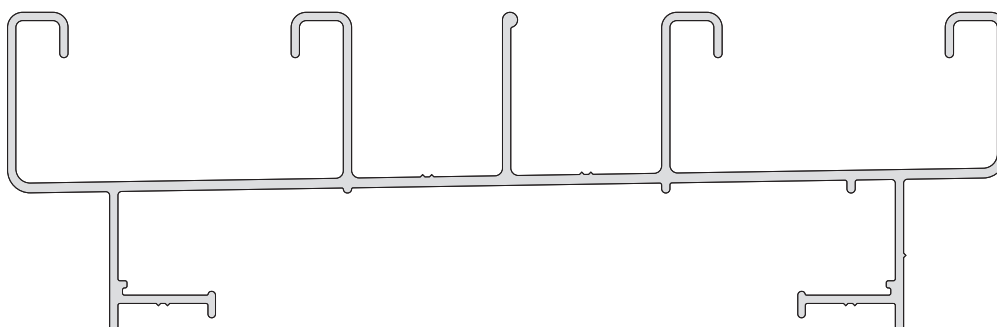

3005 / 169

Marco unific. con Postigón corredizo
 Peso 1.131 grs / mt.
 4 barras de 6.150 mm.